

TC-33 TRANSFER CASE SERVICE MANUAL

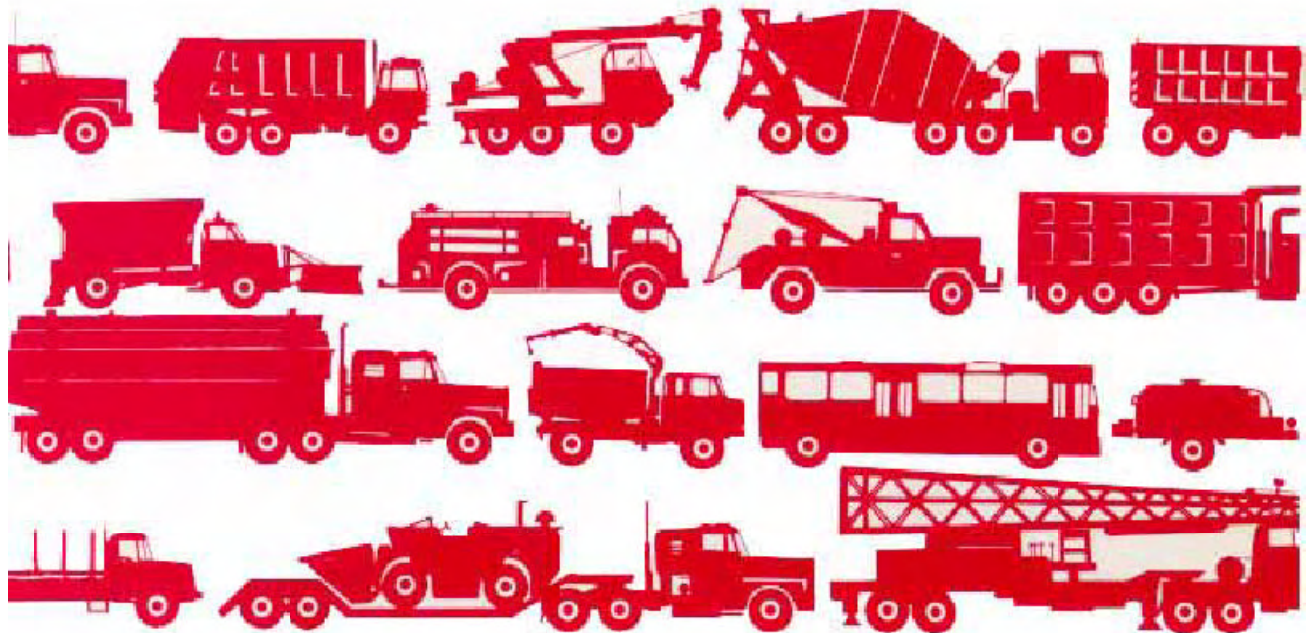

Telephone (925) 454-9500 Fax (925) 454-9501
151 Lawrence Drive, Livermore, California 94551
www.fabcoautomotive.com



A business unit of **tti**

**Fabco Automotive Corporation
Transfer Case
Service Manual
Model TC-33**

TABLE OF CONTENTS

I. Operating Instructions

A. Front Drive	3
B. Underdrive	3
C. Power Take-Off	3

II. Lubrication

A. Transfer Case Oil Change	5
B. Draining Oil	5
C. Refilling Oil	5
D. Inspection	5
E. Oil Change and Inspection Recommendations	5
F. Operating Temperature	5
G. Shift Cylinder Inspection	5

III. Transfer Case Removal and Installation

A. Removal from Vehicle	6
B. Installation into Vehicle	6

IV. Transfer Case Disassembly

A. General Precautions for Disassembly	7
B. Preparation for Disassembly	7
C. Shift Shaft Disassembly	7
D. Intermediate Shaft Disassembly	8
E. Lower Shaft Disassembly	9
F. Upper Shaft Disassembly	10

V. Cleaning and Inspection

A. Choice of Cleaning Methods	12
B. Drying and Corrosion Inhibition	12
C. Inspection	12

VI. Transfer Case Assembly

A. General Precautions for Reassembly	13
B. Stem Gear Assembly	13
C. Intermediate Shaft Assembly	14
D. Lower Shaft Assembly	16
E. Upper Shaft Assembly	16
F. Shift Shaft Assembly	19
G. Final Assembly	22

VII. Torque Specifications

VIII. Exploded Views

IX. PTO Assembly

Note: This service manual covers single and dual rear output versions of the TC-33 two-speed transfer case with either manual or air shift controls.

I. OPERATING INSTRUCTIONS

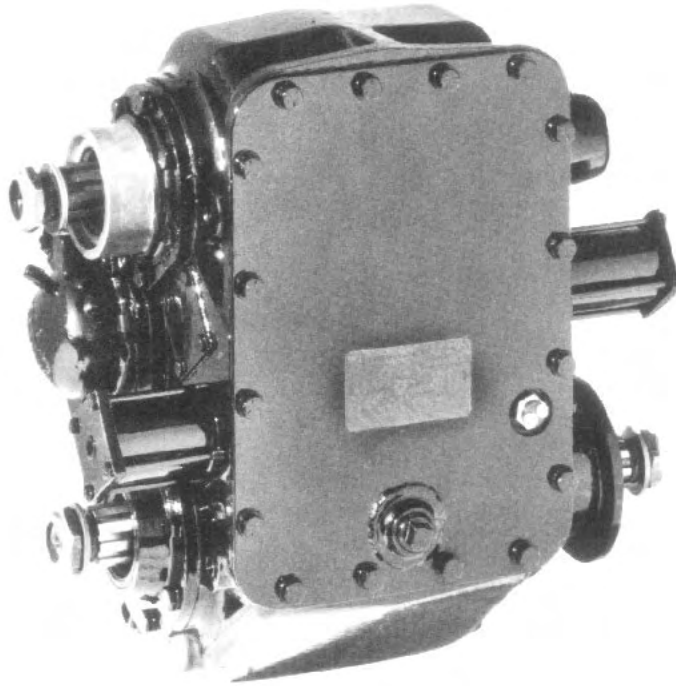

Specifications

- Ratings
 - Maximum Input Torque 3300 Lbs. Ft.
 - Maximum Input Horsepower 250 HP
 - Maximum Input Speed 3800 RPM
- Ratios
 - Direct 1:1
 - Underdrive 2.22:1
- Gear Type Helical and Spur
- Input/Output Shafts
 - 1³/₄ Inches, 10 Spline
 - Hub Diameter 2³/₈ Inches
 - Hub Depth 2³/₁₆ — 2¹/₄ Inches
- Shaft Spacing 10 Inches
- Shift Mechanism Integral Air Cylinders
- Lubrication System Splash
- Lubricant (See Lubrication Chart)
- Oil Capacity 7¹/₂ Qts.
- Weight 350 Lbs.

I. OPERATING INSTRUCTIONS

Transfer Case General Dimensions

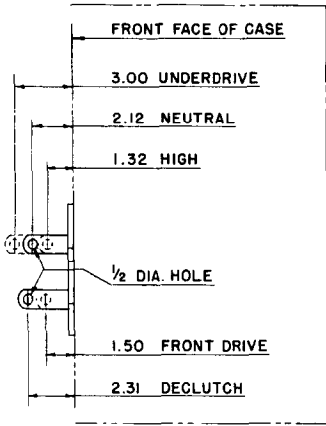

MANUAL SHIFT DETAIL

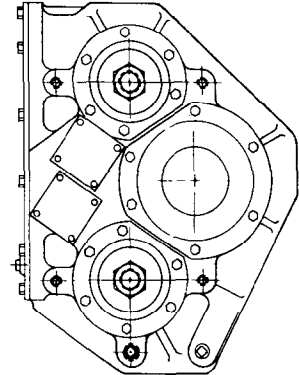
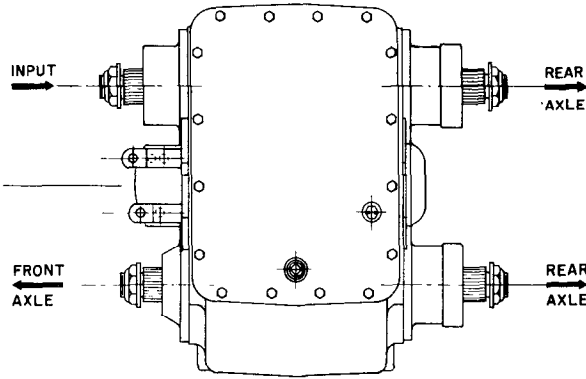

OPTIONAL DUAL REAR OUTPUT WITH MANUAL SHIFT

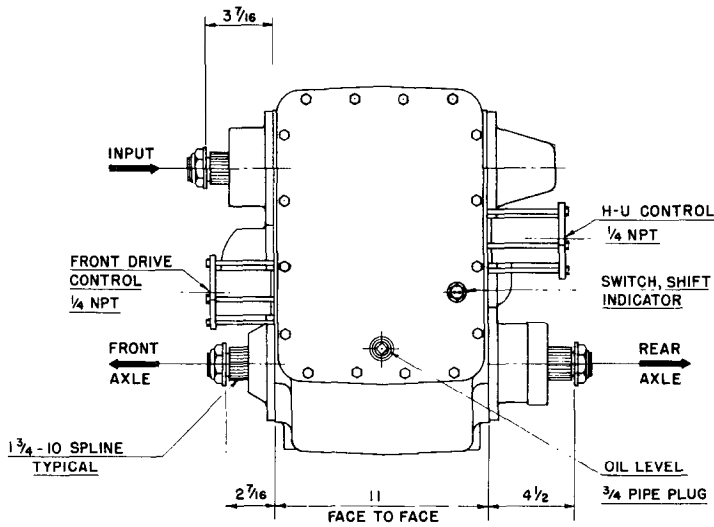

SIDE VIEW

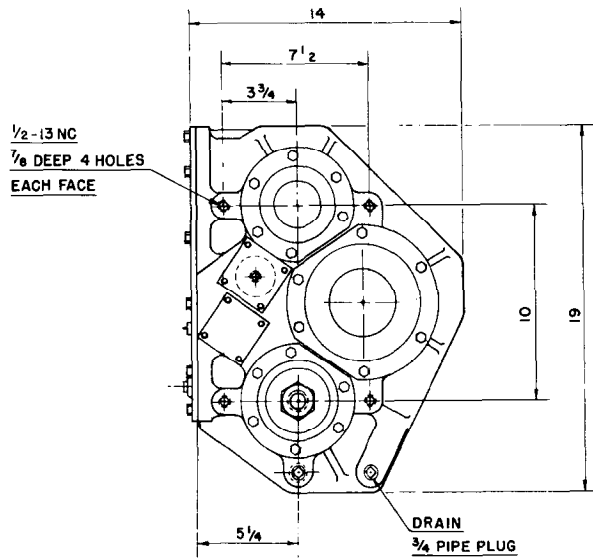

REAR VIEW

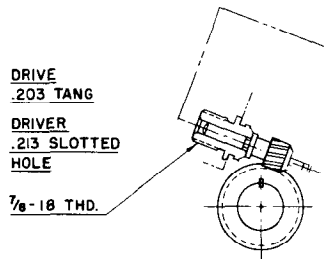

SPEEDO GEAR TURNS .242 REVOLUTIONS FOR EACH REVOLUTION OF PROPELLER SHAFT.

SPEEDO DRIVE DETAIL

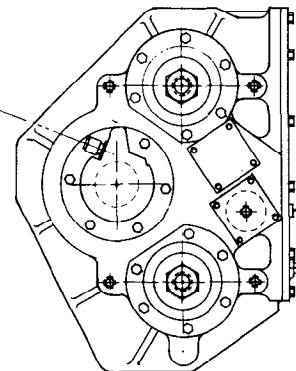

FRONT VIEW

I. OPERATING INSTRUCTIONS

A. Front Drive

When travelling through sand, loose dirt, mud, snow, ice,, or when ascending grades where the rear wheels might spin, shift to front wheel drive for better traction. Shift before the truck is in trouble. Engagement and disengagement of the front drive axle can best be made while the engine is pulling lightly.,It can be shifted at any speed provided the rear wheels are not spinning. The transfer case is equipped with a switch so that the shift is indicated by a pilot light. The light will come on when front drive is engaged.

B. Underdrive

When slow, positive pulling power is desired, shift to underdrive. Underdrive may be used to obtain a convenient combination with third or direct for climbing some grades. The transfer case should be shifted between high and low range only when the truck is stopped.

C. Power Take-Off

When the transfer case is equipped with a power take-off, the PTO can be operated without moving the vehicle. To engage, shift the automatic transmission into neutral and shift the PTO while the engine is idling. After the PTO has been engaged, shift the transmission to the desired gear. With a manual transmission equipped vehicle, depress the clutch pedal and shift into the desired transmission gear, shift the PTO and release the clutch.

To disengage the PTO, shift the transmission into neutral (manual and automatic), allow the machinery to come to rest, then disengage the PTO.

Recommended Lubricants

On Highway Vehicles

Type	Grade	Temperature
MIL-L-2104B Heavy-Duty Engine Oil	SAE 50 SAE 30	Above +10°F. Below +10°F.
Mineral Gear Oil	SAE 90 SAE 80	Above +10°F. Below +10°F.
MIL-L-2105B E.P. Oil, except Sulfur-chlorine-lead type.	SAE 90 SAE 80	Above +10°F. - Below +10°F.

Heavy-duty engine oil. Make sure to specify heavy-duty type meeting MIL-L-2104B specifications.

Mineral gear oil inhibited against corrosion, oxidation and foam.

Extreme pressure oils under some conditions might form carbon deposits on gears, shafts, and bearings which will result in transfer case malfunctions and premature failure. It is suggested that if these conditions exist, and E.P. oil is being used, a change should be made to mineral gear oil or heavy-duty engine oil as recommended.

Off Highway & Mining Equipment

Type	Grade	Temperature
MIL-L-2104B Heavy-Duty Engine Oil	SAE 50 SAE 30	Above +10°F. Below +10°F.
Special Recommendation — For extreme cold weather where temperature is consistently below 0°F.		
MIL-L-2104B Heavy-Duty Engine Oil	SAE 20W	Below 0°F.

II. LUBRICATION

Note: For proper lubricant, refer to "Recommended Lubricants" chart page 4.

A. Transfer Case Oil Change

Transfer case lubricant should be changed on all new transfer cases after the first 3,000 to 5,000 miles (on-highway), or first 40 hours (off-highway); thereafter, oil changes should be done at the following intervals:

On-Off Highway Service 10,000-15,000 miles

Off-Highway Service
(Logging, dirt moving, mining and associated operations) 500-750 hours, as indicated by operation and contamination of lubricant.

B. Draining Oil

Draining is best accomplished after the vehicle has been operated briefly, allowing the oil to become warm and flow freely. Remove both drain and fill plugs and allow housing to empty completely. After transfer case has been drained and before it is refilled, the case should be thoroughly flushed with clean flushing oil or kerosene.

C. Refilling Oil

If the transfer case has been removed from the vehicle for service, it is best to refill the oil after the transfer case has been reinstalled into the vehicle.

Clean and replace drain plug and fill the transfer case with appropriate gear oil with the vehicle on level ground (See recommended lubricant chart). Fill transfer case to the level of the fill plug, metering approximately 7½ qts. of gear oil into the transfer case. The exact amount may differ depending upon the inclination of the transfer case. Always fill to the level of the fill plug. Replace fill plug and examine transfer case for leaks around plugs and gasket sealed areas.

Do not overfill the transfer case. Overfilling may cause seepage around bearing caps.

D. Inspection

Gear oil level is to be maintained at the level of the fill plug at all times. (Check at the following intervals:

Highway Service 1,000 miles
Off-Highway Service 40 hours

E. Oil Change and Inspection Recommendations

The above oil change and inspection periods are based on the average use and operating conditions the transfer case may encounter. It is recommended that the individual owner make a periodic lab analysis of the lubricant to determine contamination based on the individual's own operating conditions. With this data the individual owner can better determine their own oil change and inspection periods.

F. Operating Temperature

The operating temperature of the transfer case should never exceed 250°F (120°C). Extensive operation at temperatures exceeding 250°F will result in rapid breakdown of the oil and shorten the transfer case life.

G. Shift Cylinder Inspection (Air Shift Cases Only)

With every oil change the air shift cylinder lines and valves should be inspected for leaks and possible malfunctioning. Low pressure conditions can cause partial clutch tooth engagement which may result in "gear jumping" and premature wear.

III. TRANSFER CASE REMOVAL & INSTALLATION

A. Removal from Vehicle

1. Remove fill and drain plugs and drain lubricant from transfer case.
2. Tag wires leading to monitor light and disconnect wires from transfer case.
3. Disconnect the air shift lines. Be sure to tag the lines for future identification (air shift cases only).
4. Disconnect mechanical linkage and tag for future identification (manual shift cases only).
5. Disconnect the speedometer cable if so equipped.
6. Disconnect drivelines at flanges or yokes.
7. Position a transmission jack of suitable capacity beneath the transfer case (350 lb. transfer case). Be sure that the transfer case is seated safely on the jack.
8. Disconnect transfer case mountings at rubber insulators. Since mountings vary, consult the vehicle service manual.
9. Check to ensure that all mountings and connections to the transfer case have been disconnected. Lower the transfer case to the floor and remove from under the vehicle.

B. Installation into Vehicle

1. Place transfer case on transmission jack and position jack and transfer case under the vehicle.
2. Raise transmission jack and position transfer case.
3. Connect transfer case mountings. Since mountings vary, consult the vehicle service manual.
4. Connect drivelines.
5. Connect shift cylinder air lines to air cylinders.
6. Connect mechanical shift linkage to shift shafts.
7. Connect monitor light lead wires to terminals.
8. Fill transfer case housing with appropriate lubricant to the correct level and install fill plug. (Refer to Lubrication, Section III).
9. Road test the vehicle by driving slowly with no load for the first few moments, then test at a higher speed listening for any problems.
10. Check transfer case for leaks around gaskets and seals.

IV. TRANSFER CASE DISASSEMBLY

A. General Precautions for Disassembly

Important: Read this section before starting the disassembly procedures.

It is assumed in the disassembly instructions that the lubricant has been drained from the transfer case and the transfer case has been removed from the chassis.

Follow each procedure closely in each section, making use of both text and pictures. Refer to the exploded views located in Section VIII as an aid in disassembly.

1. The outside of the unit should be cleaned before starting the disassembly. If steam cleaning, ensure that breather and air fittings are covered to prevent water from entering assembly.
2. Cleanliness — provide a clean place to work. It is important that no dirt or foreign material enters the unit during repairs.
3. Position the transfer case horizontally, with the cover plate facing upwards. A specially fabricated stand is desirable.
4. Assemblies — When disassembling the various assemblies, lay all parts on a clean bench in the same sequence as removed. This procedure will simplify reassembly and reduce the possibility of lost parts.
5. Bearings — Carefully wash and relubricate all bearings as removed and protectively wrap until ready for use. Remove bearings with pullers designed for this purpose, or in a manner which will not damage those bearings that will be re-used.
6. Snap Rings — Remove snap rings with pliers or special tools designed for this purpose. Rings removed in this manner can be reused.
7. When necessary to apply a force to remove a part, use of a puller or press would be preferred. However, sometimes it may be necessary to use a soft hammer or mallet.

B. Preparation for Disassembly

1. After removing the transfer case from the vehicle, remove any mounting brackets still attached to the transfer case.
2. Remove locknut and washer from each yoke or companion flange on the upper and lower shafts. Remove each companion flange or yoke from its shaft. A gear puller may be required for yoke or flange removal. Discard the used locknuts and replace with new nuts at assembly.

3. Remove bolts and lockwashers from cover plate. Tap cover plate to loosen and remove.
4. Remove hand brake assembly from lower shaft if case is so equipped.

C. Shift Shaft Disassembly

Manual Shift Cases

1. Remove bolts and lockwashers from cover plate. Tap cover plate to loosen and remove (See fig. 1).
2. Unscrew indicator light switch from housing and remove spacer washers (Note the amount of spacers removed). Remove plunger from inside housing using a magnet.
3. Cut the lockwires from the shift fork set screws on each shift fork. Remove the set screws from each shift fork.
4. Remove each detent set screw from housing. Discard set screws and replace for reassembly. Remove each detent spring and each detent ball. Detent balls are removed by using a magnet.
5. Remove four bolts from each shift shaft seal carrier and remove seal carriers from housing.
6. Withdraw each shift shaft from housing. As the shift shaft is withdrawn from the housing, remove each shift fork from the shaft.
7. Remove seal from each seal carrier, if replacement is necessary.
8. Remove shift forks from inside of housing (Labeling the shift forks according to their position in the transfer case will aid in reassembly).

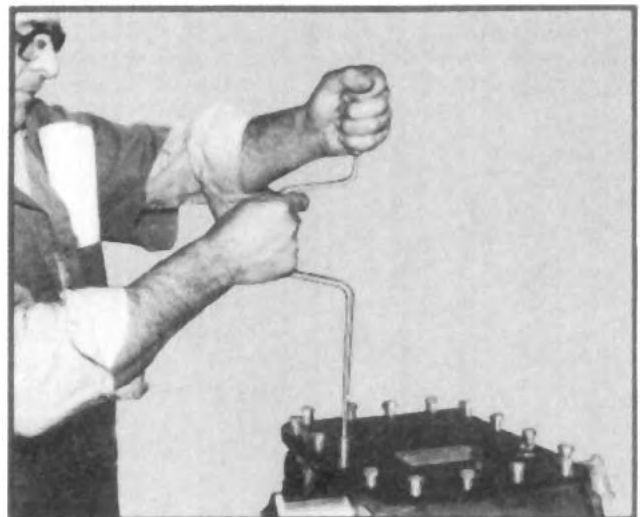

Fig. 1

IV. TRANSFER CASE DISASSEMBLY

Air Shift Cases

Underdrive/Direct Drive Shift Cylinder:

Note: If the transfer case is equipped with PTO, refer to the Power Take-Off Supplement for shift cylinder disassembly.

1. Remove bolts and lockwashers from cover plate. Tap cover plate to loosen and remove.
2. Unscrew indicator light switch from the housing and remove spacer washers (Note amount of spacers removed). Remove plunger from inside housing using a magnet.
3. Cut the lockwires from the shift fork set screws on each shift fork. Remove the set screws from each shift fork.
4. Remove four bolts from the shift cylinder cap and remove cap from shift cylinder. Discard o-ring from cylinder cap, if replacement is necessary.
5. Remove shift cylinder tube from the shift cylinder adapter tube located in the housing, exposing piston (See fig. 2).
6. Withdraw shift piston and shift shaft housing. As the shift shaft is withdrawn from the housing, remove each shift fork from the shaft.
7. Remove shift shaft spring and plastic stop ring from the shift shaft or from the shift cylinder adapter tube located in the housing.
8. Disassemble shift piston from the shift shaft (if necessary) and discard o-ring and felt wiper, if replacement is necessary.
9. Remove shift cylinder adapter tube from housing. Discard o-rings from the adapter, if replacement is necessary.
10. Remove shift forks from inside of housing.

Front Drive Shift Cylinder:

1. Follow the previous procedure for the Underdrive/Direct Drive Shift Cylinder disassembly, Steps 1 through 10.

D. Intermediate Shaft Disassembly

1. Remove speedometer adapter (if so equipped), speedometer driven gear sleeve and speedometer driven gear from front cap.
2. Remove bolts holding front and rear caps to housing. Tap front cap to loosen and remove. Use two pry bars to remove rear cap from housing.

3. Remove locknut and washer from each end of the shaft. Withdraw speedometer drive gear and spacer ring from front of shaft. Discard locknuts and replace with new locknuts at assembly.
4. Place a block of wood between the inside face of the underdrive gear and the inside of the housing. Tap the front of the intermediate shaft with a soft hammer, using care not to damage threads (See fig. 3). Align direct drive gear with intermediate shaft rear housing bore and continue to tap the shaft until it is free of the front bearing and underdrive gear bearings.

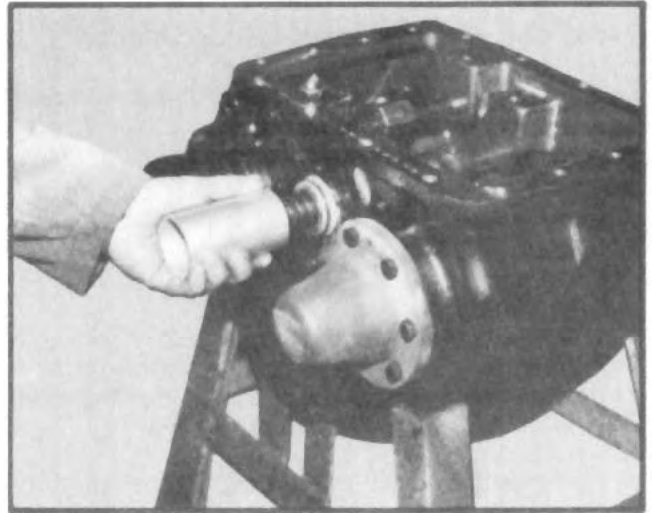

Fig. 2

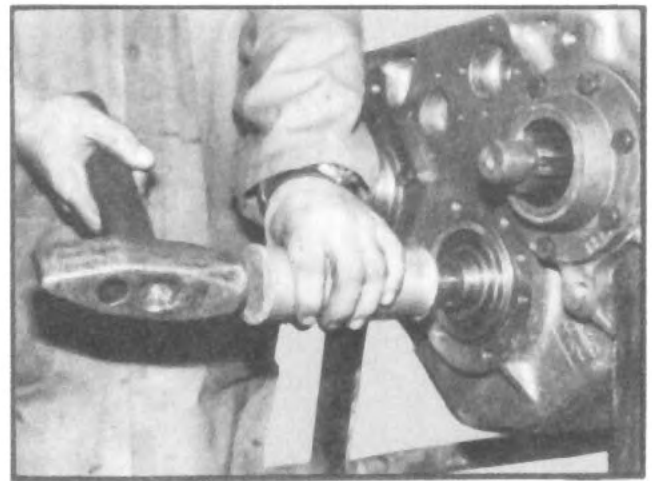

Fig. 3

IV. TRANSFER CASE DISASSEMBLY

5. Withdraw intermediate shaft and direct drive gear through rear housing bore (See fig. 4). Remove clutch gear from shaft as it is removed. Remove block of wood.
6. If necessary, remove the inner bearing race from the rear of the intermediate shaft. Disassemble intermediate shaft and gear in a press. Remove the spacer ring from the shaft (ring located between direct drive gear and raised teeth of shaft).

Note: Complete steps 7 through 9 after the upper and lower shafts have been disassembled.

7. Remove underdrive gear from inside of housing.
8. Retrieve spacer washer which will have fallen to the bottom of the housing.
9. Tap front bearing from housing with a suitable soft hammer.

E. Lower Shaft Disassembly

1. Remove bolts holding front and rear seal carriers to housing. Tap carriers to loosen and remove. If replacement is necessary, remove the seal from each carrier and discard.
2. Remove snap ring from stem gear double-row ball bearing and tap the rear of the stem gear shaft with a soft hammer, using care not to damage threads. Tap the entire lower shaft and stem gear assembly toward the front of the housing until front output shaft bearing is free from housing (See fig. 5). Separate the output shaft from stem gear single-row ball bearing. Withdraw output shaft from housing and at the same time, remove the clutch gear from the output shaft.
3. Continue tapping the stem gear shaft until the double-row ball bearing is free from the housing and withdraw stem gear assembly from inside the housing (See fig. 6).
4. If replacement is necessary, remove the single-row ball bearing from the pocket of the stem gear and the double-row ball bearing, spacer ring, and single-row ball bearing from the stem gear shaft with a suitable puller. Remove the bearing from the front output shaft.

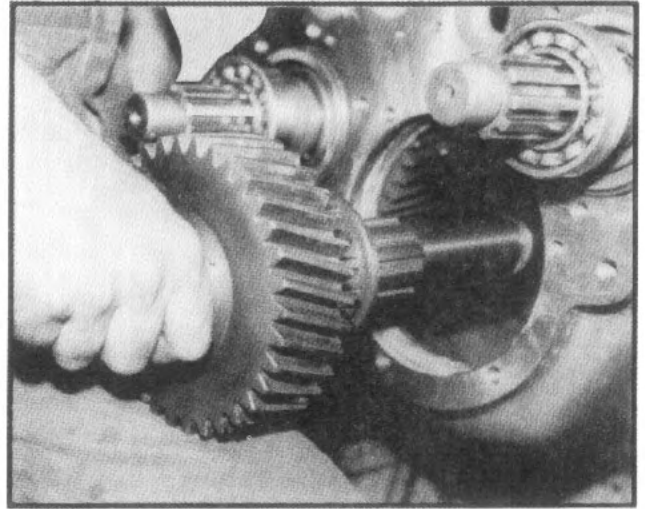

Fig. 4

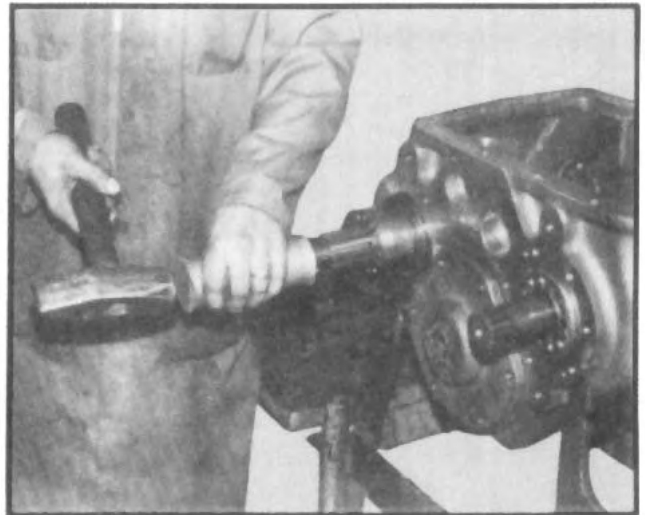

Fig. 5

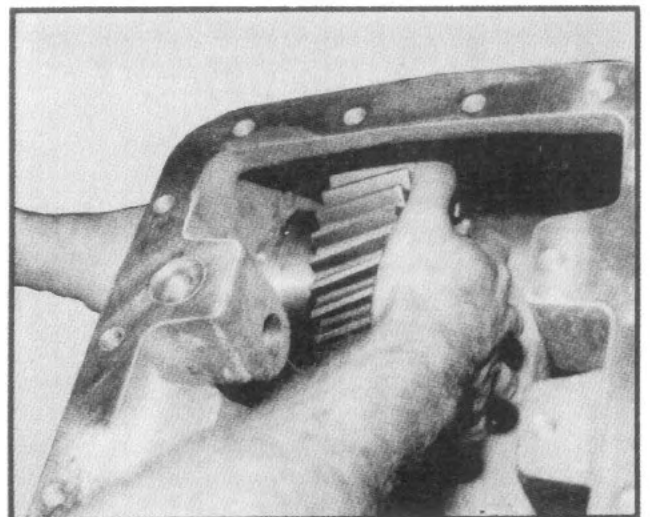

Fig. 6

IV. TRANSFER CASE DISASSEMBLY

F. Upper Shaft Disassembly

Dual Rear Output Cases:

1. Remove bolts holding front and rear seal carriers to housing. Tap carriers to loosen and remove. Remove the seal from each carrier and discard, if replacement is necessary.
2. Remove spacer ring from front of input shaft.
3. Remove the retaining ring from the shaft (See fig. 7). If the ring requires additional access tap the upper shaft toward the rear of the housing with a soft hammer, using care not to damage threads, until the underdrive gear can be pushed far enough to the front of the housing to give clearance between the gear and the retaining ring.
4. Remove snap ring from stem gear double-row ball bearing and tap the rear of the stem gear with a soft hammer using care not to damage threads. Tap the upper shaft assembly and stem gear toward the front of the housing until the front input shaft bearing is free of the housing (See fig. 8). The stem gear double-row ball bearing will also drop free. Separate the input shaft from the stem gear single-row ball bearing. Withdraw input shaft from the front of the housing, and at the same time, remove the underdrive gear and clutch gear from the shaft. Remove stem gear from inside of housing.
5. If replacement is necessary, remove the single-row ball bearing from the pocket of the stem gear and double-row ball bearing, spacer ring, and single-row ball bearing, from the stem gear shaft with a suitable gear puller. Remove the bearing from the upper shaft.

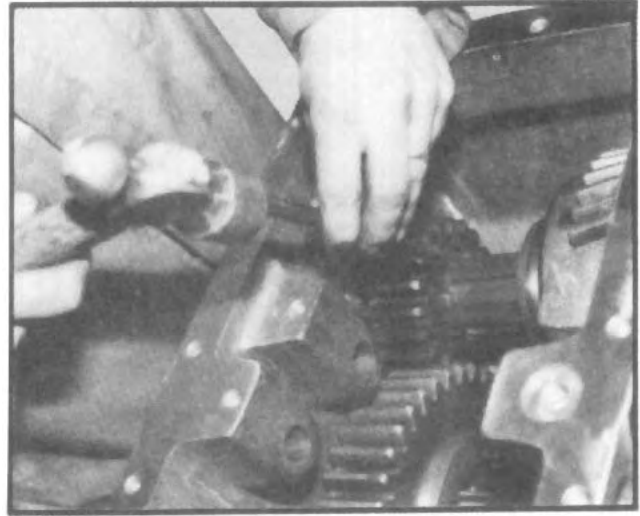

Fig. 7



Fig. 8

Single Rear Output Cases:

1. Remove bolts holding front seal carrier and rear cap to housing. Tap the front seal carrier and rear cap to loosen and remove. (Remove PTO if so equipped — see Power Take-Off Supplement.)
2. Transfer cases equipped with bearing locknuts on the rear of the shaft: Bend tabs of lockwasher and remove bearing locknuts and lockwasher from rear of upper shaft.
3. Remove the retaining ring from shaft (See fig. 7). If the ring requires additional access tap the upper shaft toward the rear of the housing with a soft hammer, using care not to damage threads, until the underdrive gear can be pushed far enough to the front of the housing to give clearance between the gear and the retaining ring.

IV. TRANSFER CASE DISASSEMBLY

4. Place a block of wood between the inside of the housing and the inside face of the direct drive gear. Tap the rear of the upper shaft with a soft hammer until the upper shaft is free of the rear bearing and both direct drive gear bearings (See fig. 9).
5. Withdraw the upper shaft through the front of the housing and at the same time remove the underdrive gear and clutch gear from the shaft. Remove block of wood.
6. Remove direct drive gear from inside of housing.
7. Tap the upper shaft bearing from the housing.
8. Retrieve the spacer washer which will have fallen to the bottom of the case.
9. If replacement is necessary, remove the upper shaft front bearing from the shaft. Remove the two bearings and spacer ring from the direct drive gear.



Fig. 9

V. CLEANING AND INSPECTION

A. Choice of Cleaning Methods

1. Steam may be used for external cleaning of completely assembled units. Care must be taken to ensure that water is kept out of the assembly by tightly closing breather caps and other openings.
2. Rough parts such as the housing, which are too large to conveniently clean with solvents, may be immersed in a hot solution tank containing a mild alkaline solution. Parts cleaned in hot solution tanks must be rinsed thoroughly to prevent damage by traces of alkaline material.
3. Parts with ground or polished surfaces, such as bearings, gears, and shafts, should be cleaned with emulsion cleaners or petroleum solvents. Alkaline hot solution tanks may damage the machined surfaces and such cleaning methods should be avoided.

B. Drying and Corrosion Inhibition

Soft, clean shop towels should be used to dry parts after cleaning. Compressed air may be used to clean inaccessible areas of large parts such as the housing. Bearings should not be spun dry with compressed air, as the lack of lubrication may cause damage to the mating surfaces.

Dried parts should be immediately coated with a light oil or corrosion inhibitor to prevent corrosion damage. Parts which are to be stored should also be wrapped in heavy waxed paper.

C. Inspection

Prior to reassembly, parts which are to be reused must be carefully inspected for signs of wear or damage. Replacement of such parts can prevent costly downtime at a future date.

All bearing surfaces, including ball bearing assemblies and roller bearing cups and cones, should be examined for pitting, wear, or overheating. Gears also may show pits, as well as scoring and broken teeth. Shafts may be nicked and marred, or may have damaged threads. Parts which show any signs of damage should be repaired or replaced.

Check all shift forks and slots in sliding clutches for extreme wear or discoloration from heat. Check engaging teeth of sliding clutches for partial engagement pattern.

VI. TRANSFER CASE ASSEMBLY

A. General Precautions for Reassembly

Important: Read this section before starting the reassembly procedure.

Make sure that interior of transfer case is clean. It is important that dirt be kept out of transfer case during reassembly. Use certain precautions, as listed below, during reassembly.

1. Gaskets — Clean all gasket surfaces of past gasket material. Use new gaskets throughout the transfer case as it is being rebuilt.
2. Bolts — To prevent oil leakage, use Permatex Form-a-Gasket #2 pliable setting sealant or equal on all threads. See torque rating chart for recommended torque, Section VII.
3. Assembly — Refer to the exploded views (located in Section VIII) as a guide to reassembly.
4. Initial lubrication — Coat all thrust washers, splines and seals with lubriplate during installation to provide initial lubrication, preventing scoring and galling.
5. Bearings — Use of flanged-end bearing drivers is recommended for the installation of bearings. These drivers apply equal force to both races of bearing, preventing damage to balls and races and maintaining correct bearing alignment with shaft and bore. If tubular or sleeve type driver is used, apply force to either outer or inner race, or both if needed, depending on which will put the bearing in place without pushing through the balls.
6. Universal joint companion flanges or yokes — Pull the companion flanges and/or yokes tightly into place with the locknuts, tightening to proper torque. Failure to pull the yoke or flange tightly into place permit the shaft to move axially with resultant damage to bearings.
7. Inspect all spacer washers and rings for wear. The width or thickness of each spacer washer or ring has been noted in the assembly procedures and each spacer should be measured with a micrometer for proper size. Worn spacers should be replaced.

B. Stem Gear Assembly

Note: The single rear output transfer case has a stem gear assembly located on the lower shaft. The dual rear output transfer case has stem gear assemblies located on the upper and lower shafts. These stem gear assemblies (See fig. 10) must be assembled to the transfer case housing before any shaft assembly is attempted.

1. Press single-row ball bearing into pocket of stem gear.
2. Press double-row bearing over stem gear shaft with snap ring facing outwards.
3. Slip spacer ring (1.250" wide) over stem gear shaft and against the bearing.
4. Press single-row ball bearing over shaft and against spacer ring.
5. Remove snap ring from double-row ball bearing (See fig. 11) and place stem gear assembly into lower shaft rear housing bore. Tap the stem gear assembly into the housing bore until there is enough room to replace the snap ring on the bearing. Replace snap ring on bearing (See fig. 12).
6. Repeat the same procedures as previously described above and assemble the upper shaft stem gear, if so equipped.

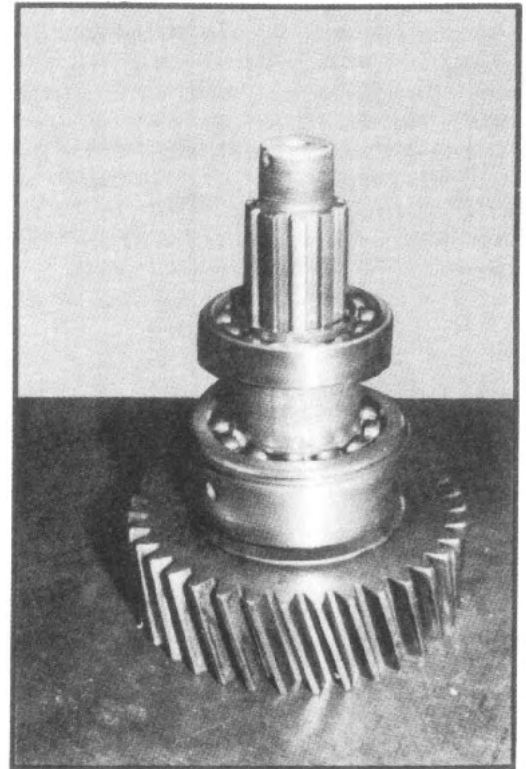

Fig. 10

VI. TRANSFER CASE ASSEMBLY

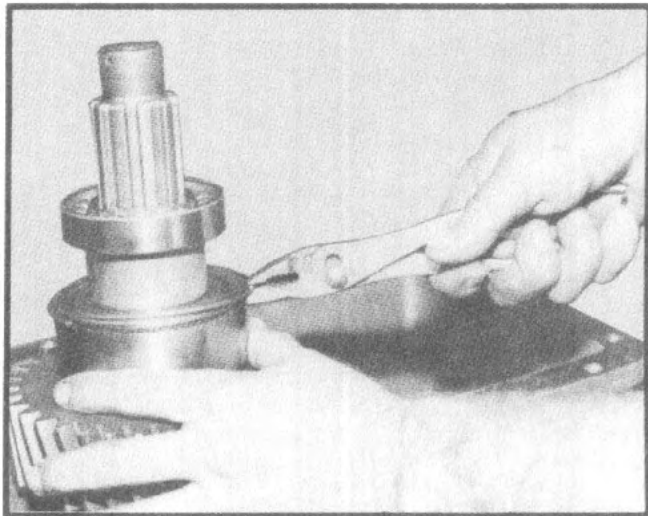

Fig. 11

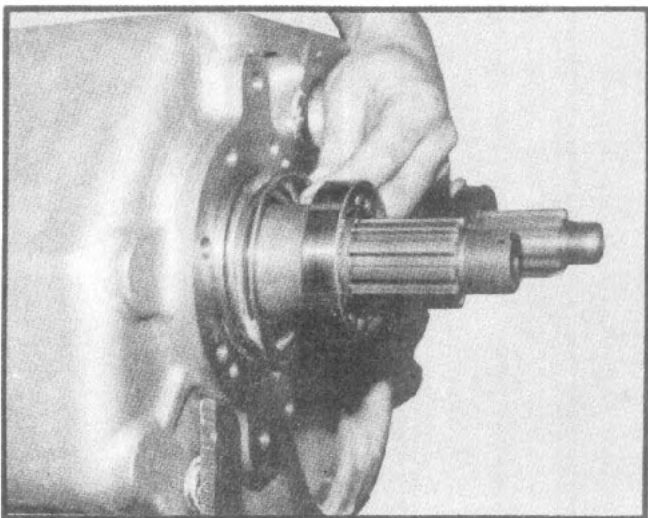

Fig. 12

C. Intermediate Shaft Assembly

1. Press intermediate shaft into direct drive gear using the following procedure:
 - a. Heat gear in oil at 250°-350°F. (120°-148°C.).
 - b. Place spacer ring (.093" wide) over rear of shaft and against the raised splines. Chamfer should face raised spline. Lubricate shaft splines with grease.
 - c. Press shaft into heated direct drive gear (See fig. 13).
2. Tap front bearing into housing bore, until snap ring is flush with housing.
3. Slide the intermediate shaft installation tool (Fabco part number 866 271, available from Fabco Automotive Corporation) through front bearing (See fig. 14) and place spacer washer (.060" wide) over end of tool and against inside face of bearing.

4. Lubricate inner diameter of underdrive gear and press front bearing into gear until snap ring is flush with face of gear. Turn gear on its opposite face and place the spacer washer (.060" wide) on top of installed bearing. Press rear bearing into gear until snap ring is flush with face of gear.
5. Place underdrive gear in housing with clutch face facing the inside of the housing. Slide the gear onto intermediate shaft installation tool.
6. Slide clutch gear over installation tool and into the underdrive gear clutch teeth.
7. Insert intermediate shaft through rear housing bore and screw shaft into end of installation tool. Pull the shaft assembly into the housing as far as possible using the tool. Tap the rear bearing over the rear of the shaft with a suitable tool. Be sure the shoulder of the inner race is against the gear. Continue to tap the bearing to install the intermediate shaft into the underdrive gear bearings. When the shaft is completely into the underdrive gear bearings remove the installation tool from the shaft. Tap the rear of the shaft to install into front bearing.

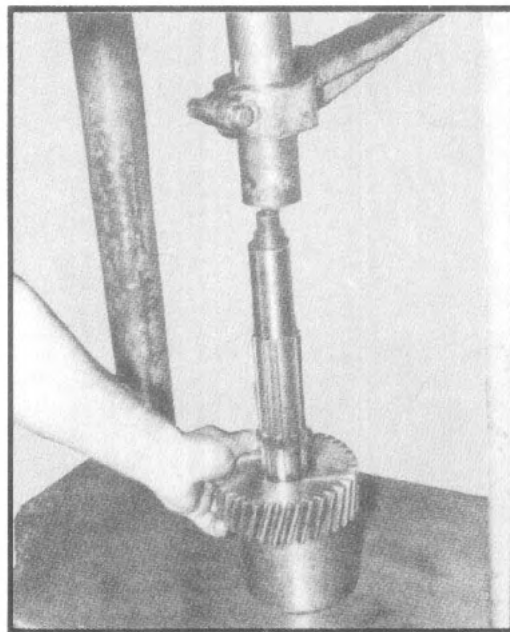

Fig. 13

VI. TRANSFER CASE ASSEMBLY

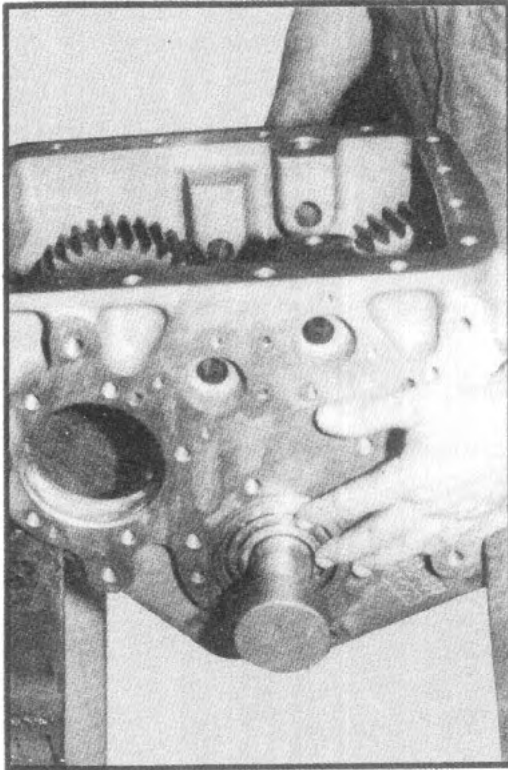

Fig. 14

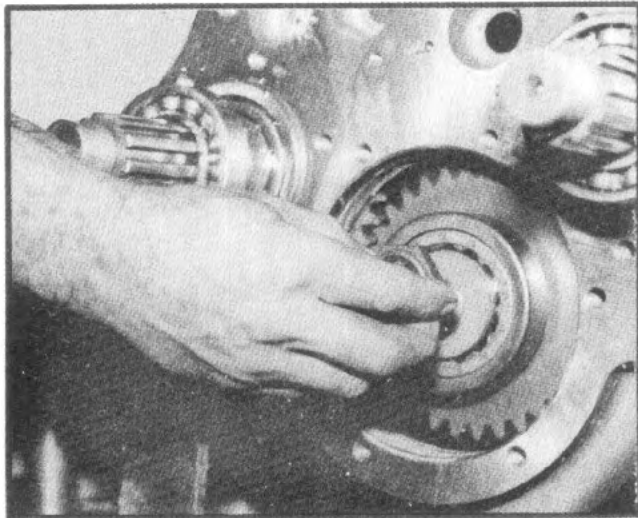

Fig. 15

8. Assemble washer and locknut to rear of shaft. Tighten locknut to correct torque (See fig. 15).
9. Place speedometer drive gear spacer ring (.082" wide) over front of shaft and against front bearing. Place speedometer drive gear over front of shaft (See fig. 16). Secure locknut to front of shaft and tighten nut to correct torque.

10. Assemble front cap and gasket to housing and secure to housing with six bolts. Be sure to align oil passages. Tighten bolts to correct torque. Inspect condition of breather on front cap and replace if necessary.
11. Install speedometer driven gear and speedometer driven gear sleeve to front cap (See fig. 17). Install speedometer adapter, if so equipped.
12. Install the rear cap and gasket over rear of shaft and into housing bore. Be sure to align oil passages and that the roller bearing assembly is seating properly into the rear cap as it is installed. Secure rear cap and gasket to housing with six bolts. Tighten bolts to correct torque.

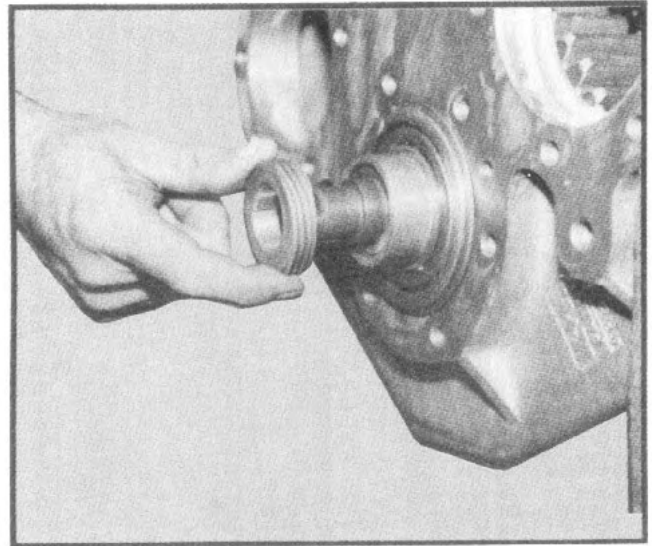

Fig. 16

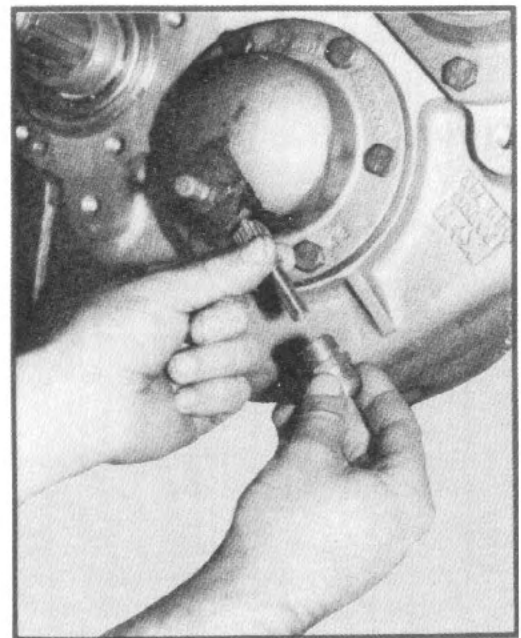

Fig. 17

VI. TRANSFER CASE ASSEMBLY

D. Lower Shaft Assembly

1. Refer to this Section, part B and assemble the stem gear assembly. Assemble stem gear assembly to rear of housing.
2. Slide the clutch gear into the stem gear clutch teeth (See fig. 18).

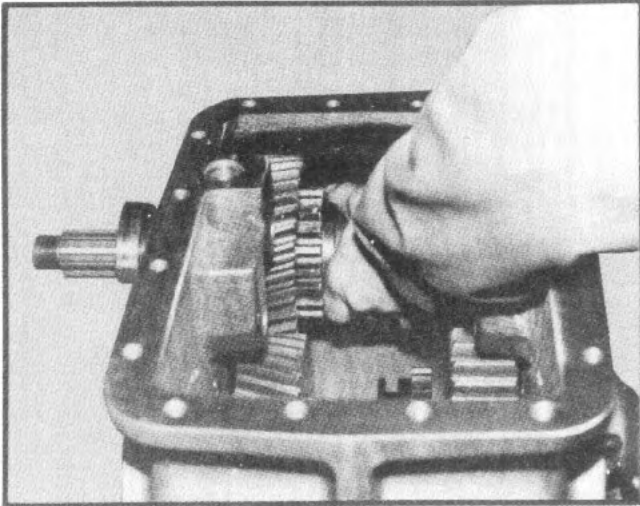

Fig. 18

3. Insert front output shaft into housing and tap shaft into the single-row ball bearing in the stem gear pocket. Use care not to damage threads on end of shaft.
4. Tap output shaft bearing over end of shaft and into the housing with a suitable bearing driver (See fig. 19).

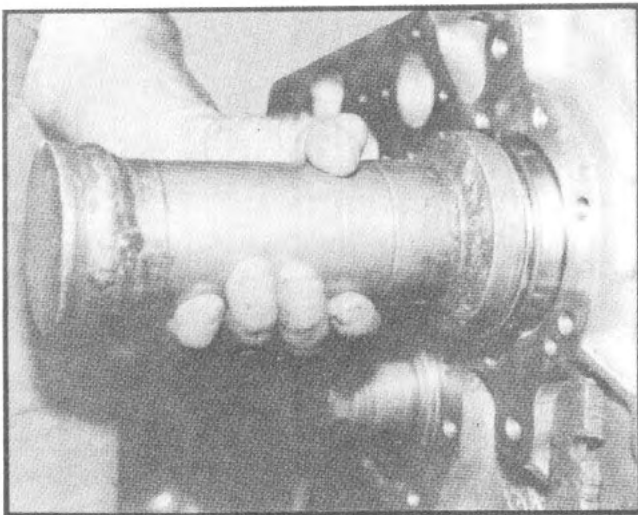

Fig. 19

5. Install seal into front carrier. Assemble front seal carrier and gasket to housing align the oil passages and secure seal carrier to housing with six bolts. Tighten bolts to correct torque.
6. Install seal into rear seal and bearing carrier. Place carrier gasket over stem gear shaft and against housing. Tap carrier over stem gear shaft bearing and against housing. Be sure to align oil passages. Secure seal and bearing carrier to housing with six bolts. Tighten bolts to correct torque.

E. Upper Shaft Assembly

Single Rear Output Cases:

1. Press direct drive gear front bearing into gear until snap ring is flush with face of gear. Turn gear on its opposite face and place spacer ring (.695" wide) on top of installed bearing. Press bearing into gear until snap ring is flush with face of gear.
2. Place direct drive gear in housing with clutch face facing the inside of the housing.
3. Slide the clutch gear into the direct drive gear clutch teeth (See fig. 20).

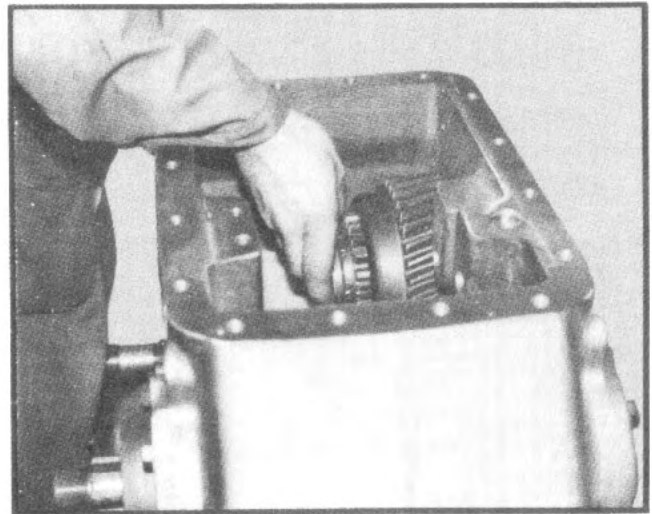

Fig. 20

VI. TRANSFER CASE ASSEMBLY

4. Insert upper shaft through front housing bore and at the same time slide the underdrive gear over the shaft (See fig. 21). The underdrive gear must be positioned with the inside diameter chamfer facing the inside of the case. Insert the upper shaft into the clutch gear and direct drive gear bearings as far as the shaft will go by hand.
5. Supporting the assembly, tap front of upper shaft with a soft hammer to install shaft through direct drive gear bearings. Use care not to damage threads on end of shaft. As the shaft enters the direct drive gear bearings, align the spacer ring between the bearings to slip over the shaft. Tap shaft into bearings until the splines of the shaft are flush with the front direct drive gear bearing.
6. Place spacer washer (.060" wide) over rear of shaft and against the rear direct drive gear bearing (See fig. 22).
7. Supporting the shaft assembly, tap rear bearing over end of upper shaft and into housing bore using a suitable bearing driver.
8. Slide underdrive gear to the front of the housing and tap retaining ring over shaft (See fig. 23). Slide underdrive gear against the ring. Tap front bearing into housing until snap ring on bearing is flush with face of housing.
9. Transfer cases equipped with bearing locknuts on the rear of the upper shaft: Assemble the bearing locknut and lockwasher to the rear of the upper shaft. Bend tabs of lockwasher over each bearing locknut (See fig. 24).



Fig. 21



Fig. 22



Fig. 23

VI. TRANSFER CASE ASSEMBLY

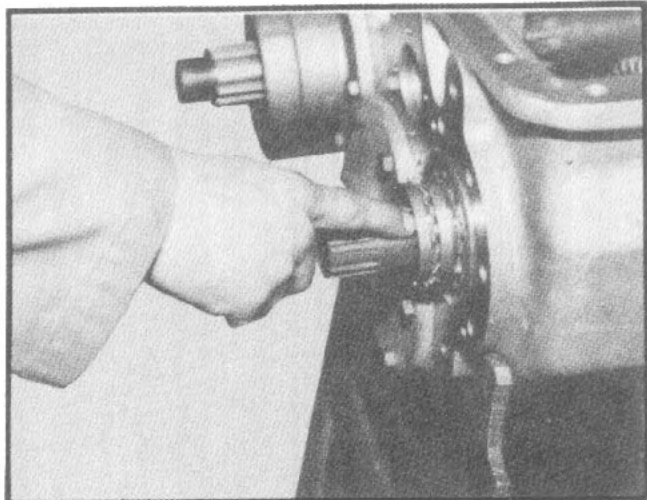

Fig. 24

10. Replace P.T.O. if so equipped (see Power Take Off Supplement) or assemble rear cap as follows: Secure rear cap to housing with three bolts finger tight. Measure distance between rear cap flange and housing with feeler gauges. Add .005" to this dimension and use the proper amount of shims to match this calculated dimension. Remove rear cap and bolts, place shims under the cap and secure cap with bolts. Be sure to align the oil passages. Tighten bolts to correct torque.
11. Slip spacer ring (1.000" wide) over front of upper shaft and against upper shaft front bearing (See fig. 25).
12. Install seal into front seal carrier, assemble seal carrier and gasket to housing, align the oil passages and secure seal carrier to housing with six bolts. Tighten bolts to correct torque.

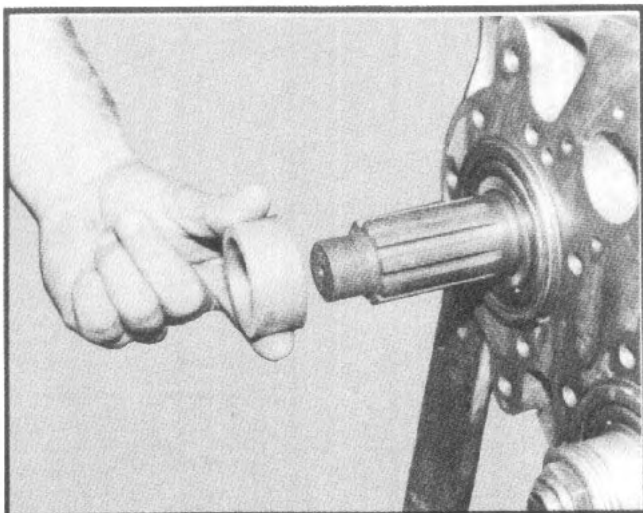

Fig. 25

E. Upper Shaft Assembly (continued)

Dual Rear Output Cases:

1. Refer to this Section, part B and assemble the stem gear assembly. Assemble stem gear assembly to rear of housing.
2. Slide the clutch gear into the stem gear clutch teeth (See fig. 26).
3. Insert input shaft through upper shaft front bore and at the same time place the underdrive gear over the splines of the shaft. The underdrive gear must be positioned with the inside diameter chamfer facing the inside of the case. Tap input shaft into single-row ball bearing located in the stem gear pocket. Use caution not to damage threads on the front of the input shaft.
4. Slide the underdrive gear to the front of the housing and tap retaining ring over the shaft (See fig. 23). Slide the underdrive gear against the ring.

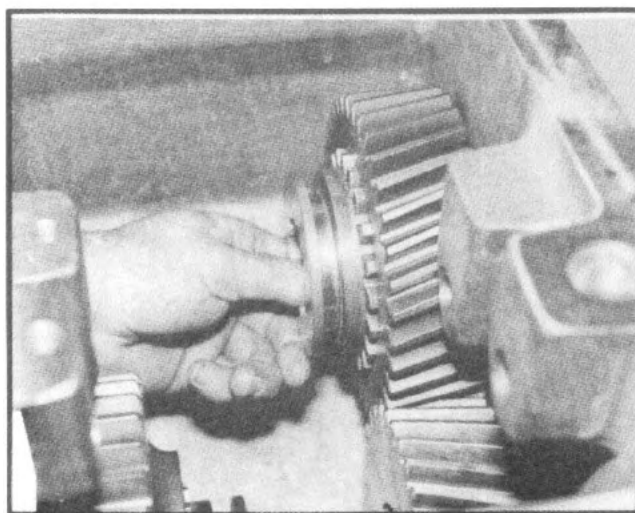

Fig. 26

VI. TRANSFER CASE ASSEMBLY

5. Tap input shaft bearing over the front of shaft and into housing with a suitable driver (See fig. 27).
6. Slip spacer ring (1.000" wide) over front of input shaft and against bearing (See fig. 25).
7. Install seal into front seal carrier, assemble seal carrier and gasket to housing, align the oil passages and secure seal carrier to housing with six bolts. Tighten bolts to correct torque.
8. Install seal into rear seal and bearing carrier. Place carrier gasket over shaft and against housing. Tap carrier over stem gear shaft bearing and against housing. Be sure to align the oil passages. Secure seal and bearing carrier to housing with six bolts. Tighten bolts to correct torque.

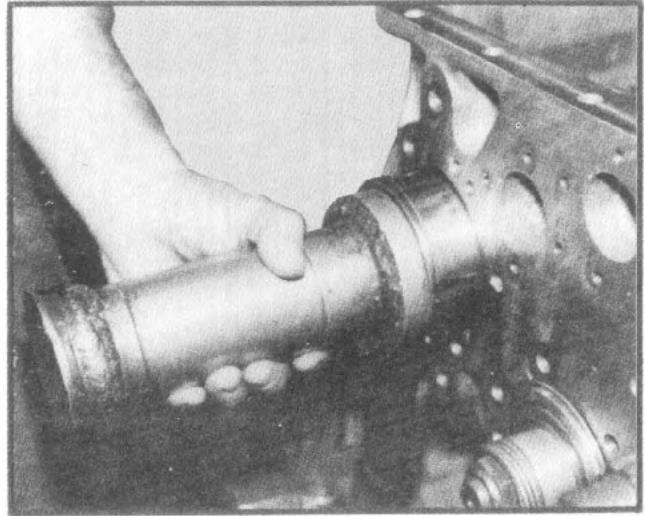

Fig. 27

F. Shift Shaft Assembly

Manual Shift Cases:

1. Place each shift fork on its proper clutch gear. The position of the *upper* and *intermediate shaft* clutch gear forks will differ according to transfer case style: The single rear output case shift forks are assembled as follows: (refer to fig. 28).
 - a. The shorter shift fork is placed on the input shaft clutch gear with the flat side of the fork to the rear of the housing.
 - b. The longer shift fork is placed on the intermediate shaft clutch gear with the flat side of the fork to the front of the housing.
 - c. The shift forks are placed back to back with the shorter fork to the front of the housing.

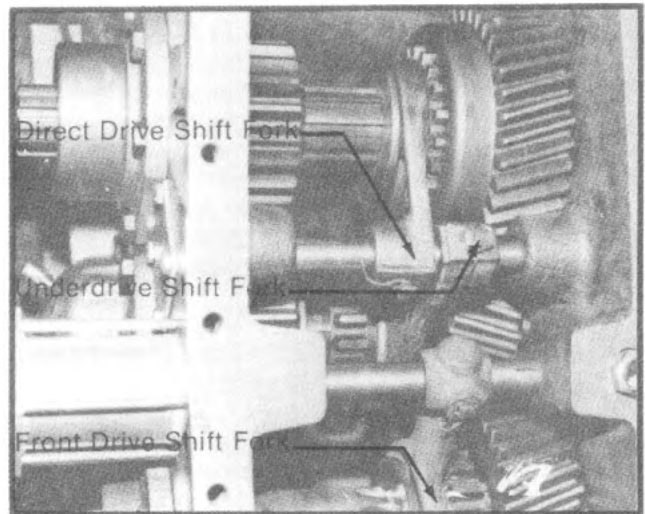

Fig. 28 Single Rear Output Transfer Case Shift Fork Positions

The dual rear output case shift forks are assembled as follows: (refer to fig. 29).

- a. The shorter shift fork is placed on the input shaft clutch gear with the flat side of the fork to the front of the housing.
- b. The longer shift fork is placed on the intermediate shaft clutch gear with the flat side of the fork to the rear of the housing.
- c. The shift forks are placed back to back with the shorter fork to the rear of the housing.

Place remaining front drive shift fork onto lower shaft clutch gear.

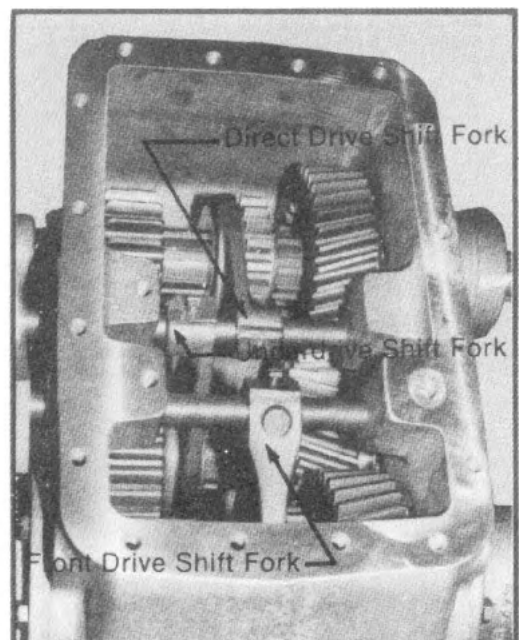

Fig. 29 Dual Rear Output Transfer Case Shift Fork Positions

VI. TRANSFER CASE ASSEMBLY

2. Insert front drive shift shaft (three-notch shaft) through hole closest to bottom of housing. Insert shaft through shift fork located on lower clutch gear and slide shaft into rear housing bore. Rotate shaft so flat section of shaft is turned away from the front drive indicator switch hole.
3. Insert underdrive/direct drive shift shaft (five-notch shaft) through hole located next to front drive shift shaft. As shaft enters inside of housing, insert shaft through shift forks located on intermediate and upper shaft clutch gears and slide shaft into rear housing bore.
4. Install a shift fork set screw into each shift fork and align the shift shaft notch with the set screw. Tighten each set screw and secure with lockwire (See fig. 30 and 31).
5. Insert each detent ball and detent spring into proper bore in top of housing. Install each detent set screw and tighten until it takes a force of 25-40 lbs. to push the shift shaft out of detent.
6. Install plunger into front drive indicator switch hole with rounded side of plunger against shift shaft (See fig. 32). Place one copper washer on the indicator switch and install indicator switch into housing. Tighten switch securely. Check operation of switch with a circuit tester, while operating the shift shaft. Add washers as necessary until switch operates properly.
7. Install cover and gasket on open end of each shift shaft bore.
8. Press a seal into each shift shaft seal carrier and assemble a seal carrier to each shift shaft. Secure seal carrier to housing with four bolts.

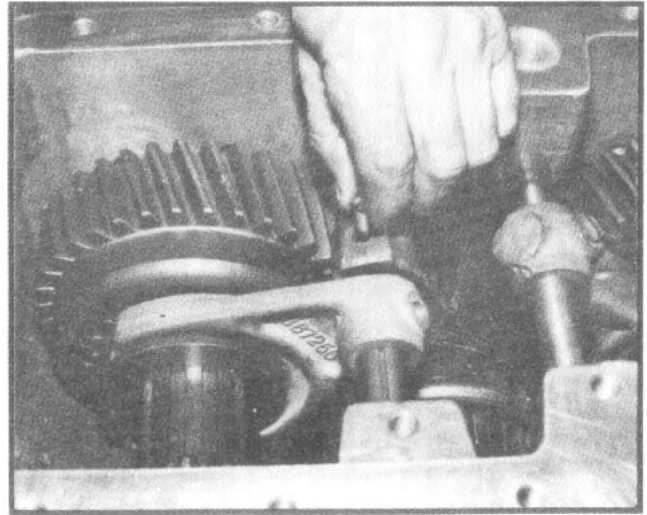

Fig. 30

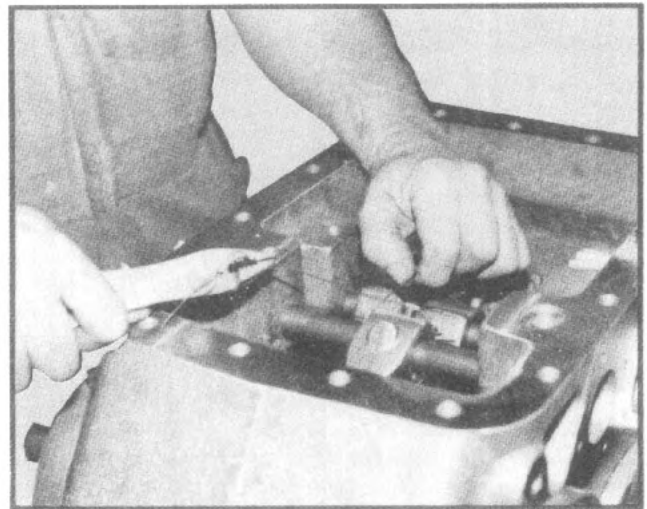

Fig. 31

Air Shift Cases:

Front Drive Shift Cylinder:

1. Install two o-rings into shift cylinder adapter tube, coat adapter tube with gear lubricant, and install adapter into front of housing (See fig. 33).
2. Place small o-ring over threaded end of front drive shift shaft (one notch shaft) and against shift shaft shoulder.
3. Place piston over shift shaft with the shallower of the two grooves toward the shaft. Make sure small o-ring on shaft is seating in chamfer in piston bore. Assemble washer and locknut to end of shift shaft.
4. Place spring over end of shift shaft and against piston. Place plastic stop ring over spring.

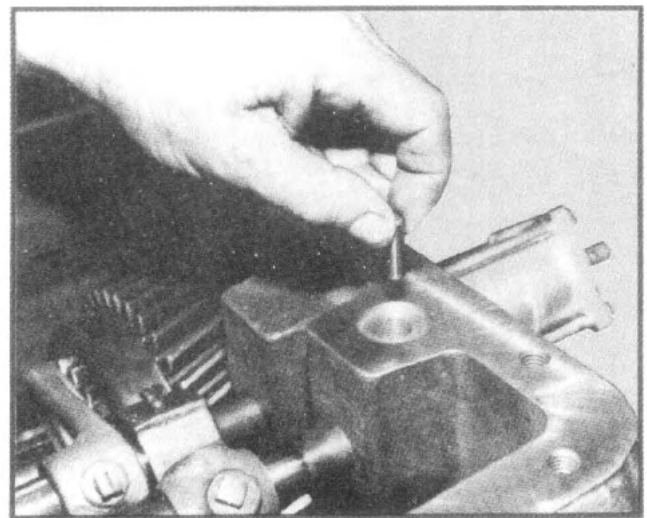

Fig. 32

VI. TRANSFER CASE ASSEMBLY

5. Place front drive shift fork on clutch located on lower shaft.
6. Insert shift shaft through front housing bore closest to bottom of housing. As the shaft enters inside of housing, insert shaft through shift fork located on lower shaft clutch gear and slide shaft into rear housing bore (See fig. 34). Rotate shaft so flat section of shaft is turned away from the front drive indicator switch hole.
7. Install shift fork set screw into shift fork and align the shift shaft notch with the set screw. Tighten set screw and secure with lockwire (See fig. 30 and 31). Torque piston locknut to correct torque.
8. Place an oil soaked felt wiper in shallow groove on piston and an o-ring into the deep groove (See fig. 35).
9. Coat the shift cylinder tube lightly with gear lubricant, install cylinder tube over piston and seat cylinder tube over the o-ring in the adapter tube.
10. Install o-ring into shift cylinder cap and install cylinder cap into the cylinder tube. Secure assembly with bolts and tighten bolts evenly to prevent misalignment of cylinder cap. Tighten bolts to correct torque.
11. Install plunger into front drive indicator switch hole with rounded side of the plunger against the shift shaft (See fig. 32). Place one copper washer on the indicator switch and install indicator switch into housing. Tighten switch securely. Check operation of switch with a circuit tester, while operating the shift shaft. Add washers as necessary until switch operates properly.

Underdrive/Direct Drive Shift Cylinder:

Note: If transfer case is equipped with a neutral position between the underdrive and direct drive position for PTO operation, see PTO supplement for Underdrive/Direct Drive Shift Cylinder Assembly.

1. Install two o-rings into shift cylinder adapter tube, coat adapter tube with gear lubricant, and install tube into rear of housing (See fig. 33).
2. Place underdrive shift fork on the intermediate shaft and direct drive shift fork on the upper shaft. See this Section and follow part F, step 1.
3. Insert underdrive/direct drive shift shaft (two-notch shaft) through rear housing bore closest to top of housing. As shaft enters inside of housing, insert shaft through shift forks located on the upper and intermediate shaft clutch gears. Slide shaft into front housing bore.

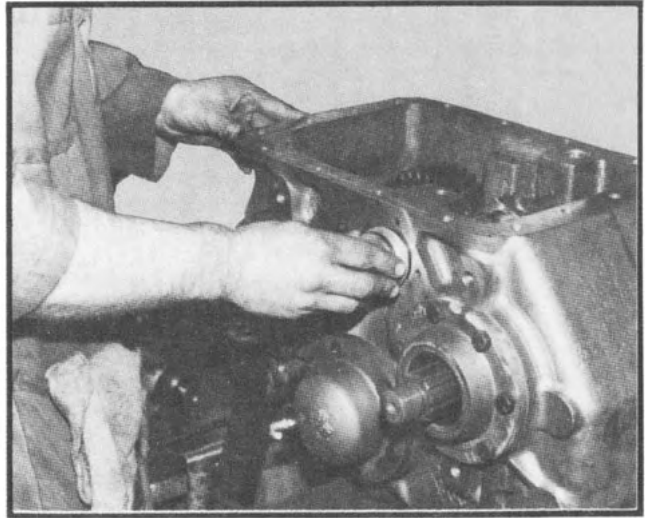

Fig. 33

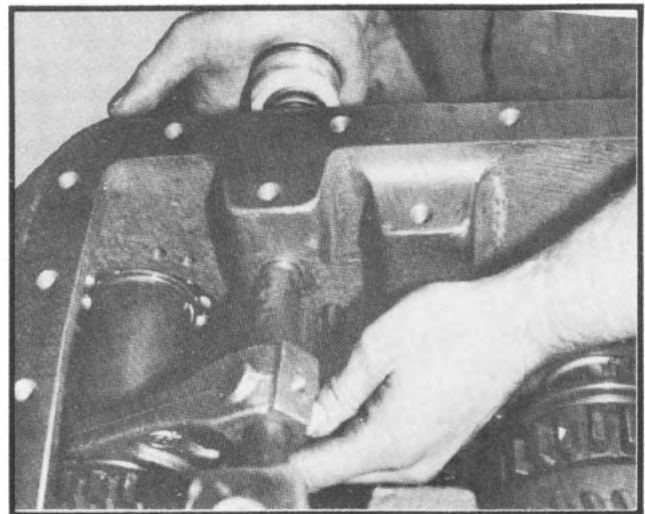

Fig. 34

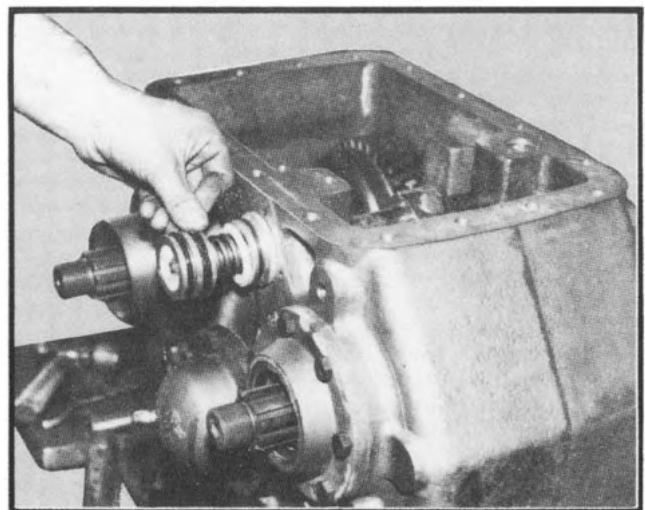

Fig. 35

VI. TRANSFER CASE ASSEMBLY

4. Install a shift fork set screw into each shift fork and align each shift shaft notch with each set screw. Tighten each set screw and secure each screw with lockwire.
5. Place small o-ring over threaded end of shift shaft and against shift shaft shoulder.
6. Place spring over end of shift shaft and into adapter. Place plastic stop ring over spring.
7. Place piston over shift shaft with the shallower of the two grooves toward the shaft. Make sure small o-ring on shaft is seating in chamfer in piston bore. Depress the spring with the piston and secure piston with the washer and locknut. Tighten locknut to correct torque. Place an oil-soaked felt wiper in shallow groove on piston and an o-ring in the deep groove. (See fig. 35).
8. Coat the shift cylinder tube lightly with gear lubricant, install cylinder tube over piston and seat cylinder tube over o-ring in the adapter tube.
9. Install o-ring in shift cylinder cap and install cylinder cap into the cylinder tube. Secure assembly with bolts and tighten bolts evenly to prevent misalignment of cylinder cap. Tighten bolts to correct torque.
10. Install each cover and gasket on open end of each shift shaft bore.

G. Final Assembly

1. Assemble handbrake assembly to rear of lower shaft if case is so equipped.
2. Install cover plate and gasket to housing and secure with sixteen bolts and lockwashers. Tighten bolts to correct torque.
3. Coat each flange or yoke hub with gear lubricant and install each flange or yoke to its corresponding shaft. Secure the flange or yoke to the shaft with the proper washer and locknut. Tighten locknuts to correct torque.
4. Attach all mounting brackets that must be secured to the transfer case before the case can be installed in the truck.
5. Install seal sleeve (if so equipped) on rear of upper shaft and secure with washer and locknut. Tighten locknuts to correct torque.

VII. TORQUE SPECIFICATIONS

Location	Size	Grade	Torque (Lbs.-Ft.)
Upper Shaft:			
Front seal carrier bolts	$\frac{7}{16}$ -14 x 1 $\frac{1}{4}$	5	65
Rear cap or rear seal carrier bolts	$\frac{7}{16}$ -14 x 1 $\frac{1}{4}$	5	65
Input yoke nut	1 $\frac{1}{4}$ -18	—	300
Rear output yoke nut	1 $\frac{1}{4}$ -18	—	300
Rear bearing retaining nuts (2 total — single rear output cases — if so equipped)	1 $\frac{3}{4}$ -18	—	125
Intermediate Shaft:			
Front and rear locknuts	1-20	—	175
Front and rear cap bolts	$\frac{7}{16}$ -14 x 1 $\frac{1}{4}$	5	65
Lower Shaft:			
Front and rear seal carrier bolts	$\frac{7}{16}$ 14 x 1 $\frac{1}{4}$	5	65
Shift Shafts:			
Manual Shift Cases: Shift shaft seal carrier bolts	$\frac{1}{4}$ -20 x 1	5	15
Air Shift Cases: Shift shaft piston nuts	$\frac{3}{8}$ -24	—	30
Front drive shift cylinder cap bolts	$\frac{1}{4}$ -20 x 4	5 or 8	15
H-U shift cylinder cap bolts	$\frac{1}{4}$ -20 x 5	5 or 8	15
H-N-U shift cylinder stud nuts	$\frac{1}{4}$ -20	—	15
Fork Screw, Set	$\frac{3}{8}$ -16	—	15
Miscellaneous:			
Cover plate bolts	$\frac{7}{16}$ -14 x 1	5	45